

FUNCTIONS OF VALVE POSITIONS 阀门功能

Valve Position 阀门位置	Functional 功能
FILTER	Normal Filtration 正常过滤
BACKWASH	Cleaning Filter by reversing the flow 倒冲洗 (将过滤器内渣物排出)
RINSE	Used after backwash to flush dirt from valve 当倒冲洗后剩余在管内之渣物排出
WASTE	By-passes filter, used for vacuuming to waste or lowering water level 排水
RECIRCULATE	By-passes filter for circulating water to pool 不经过滤器循环
CLOSED	Shuts off all flow to filter or pool 关 (将过滤器内之功能关上)

FILTER 正常过滤

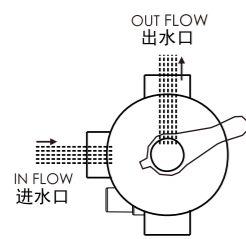

WASTE 不经过滤直接排水

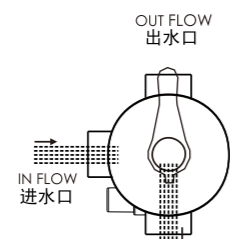

CLOSED 关闭过滤功能

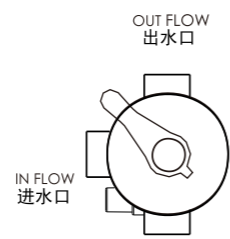

BACKWASH 倒冲洗

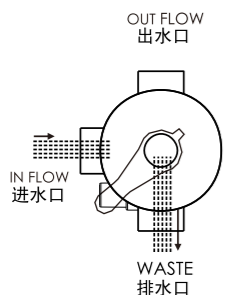

RINSE 倒冲洗后冲洗管道

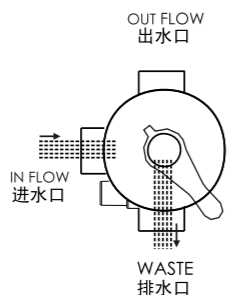

RECIRCULATE 不经过滤器循环

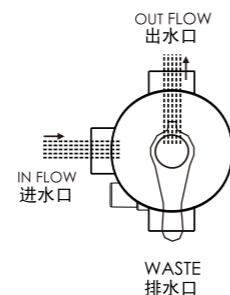

GENERAL

- 1) Pipe tap boss provided for optional influent pressure gauge.
- 2) SERVICING VALVE(Stop pump,close gate valve in suction&discharge before proceeding):
 - a) Set handle in filter position.
 - b) Remove cover screws.
 - c) Lift cover and key assembly out.

TO ASSEMBLE:

- 1) Place valve key so that wedge opening is at TOP port (handle in Filter psn.). Flat edge of cover screw lug should align with flat edge of body screw lug.
- 2) Position cover O'Ring.
- 3) Secure assembly to body with cover screws. Tighten cover screws evenly and alternately. Do not over-tighten.

综合简介:

- 1) 喉管上的水龙头能控制水流, 而能随意影响到压力表。
- 2) 维修缸头(维修缸头前, 请先关闭水泵及管道阀制)。
- a) 手柄应设定在正常过滤位置。 B. 扭开沙缸头面盖上的螺丝。 c. 抬起手柄, 将面盖连分水器取出。

装配简介:

- 1) 面盖胶圈放于面盖正确位置。
- 2) 握住手柄, 将面盖连分水器放入缸头身, 面盖上定位钉插入缸头身上小孔, 手柄对着1档位置(手柄在正常过滤位置), 将螺丝孔及边对齐。
- 3) 对称上好螺丝, 均匀用力, 将螺丝拧紧, 但不能拧得过硬。

WARNING 警告

- ⚠ THIS FILTER OPERATES UNDER HIGH PRESSURE. WHEN ANY PART OF THE CIRCULATING SYSTEM (e.g., CLAMP, PUMP, FILTER, VALVES, ETC.) IS SERVICED, AIR CAN ENTER THE SYSTEM AND BECOME PRESSURIZED. PRESSURIZED AIR CAN CAUSE THE LID OR VALVE TO BE BLOWN OFF WHICH CAN RESULT IN SEVERE INJURY, DEATH, OR PROPERTY DAMAGE. DO NOT UNSCREW SCREWS OF FLANGE CLAMP WHILE FILTER OPERATING.
- ⚠ TURN PUMP OFF BEFORE CHANGING VALVE POSITION.
- ⚠ TO PREVENT DAMAGE TO THE PUMP AND FOR PROPER OPERATION OF THE SYSTEM, CLEAN PUMP STRAINER AND SKIMMER BASKETS REGULARLY.
- ⚠ 沙缸操作时会在高压下运作。当其中一部份打开(接合, 水泵, 沙缸, 阀门等等)需要修理, 空气便能进入系统内而改变大压力, 使而气压导致外壳或阀门等爆炸, 造成受伤或环境破坏, 因此沙缸运行时请勿扭动缸头上的螺丝。
- ⚠ 转换阀门功能制时, 先停止水泵的运作。
- ⚠ 防止水泵受损, 要定期清理水泵内的隔发器和池面撇渣器内的垃圾。

**HD 系列高压缸使用说明书
Deep Bed Filter User Manual**

**Models(型号):13300 / 13350 / 13400 /
15300 / 15350 / 15400**



FUNCTION 功能简介

The filter uses special filter sand to remove dirt particles from pool water. The filter sand is loaded into the filter tank and functions as a permanent dirt removing media. When the control valve is in the FILTER position, the pool water which contains suspended dirt particles, is pumped through your piping system and is automatically directed by the patented filter control valve to the top of the filter tank. As the pool water is pumped through the filter, dirt particles are trapped by the sand bed, and filtered out. The cleaned Pool water is returned from the bottom of the filter tank, through the control valve and back to the pool through the piping system. This entire sequence is continuous and automatic. It provides for total recirculation of pool water through your filter and piping System.

After a period of time, the accumulated dirt in the filter causes a resistance to flow, and the flow diminishes. This means it is the time to clean your filter. With the control valve in the BACKWASH position, the water flow is automatically reversed through the filter so that it is directed to the bottom of the tank, up through the sand, flushing the previously trapped dirt and debris out the waste line. Once the filter is back-washed of dirt, set control valve to RINSE position and run pump for about 1/2 to 1 minute, and then set the control valve in the FILTER position, to resume normal filtering.

NOTE: Turn pump off before changing valve position.

沙缸功能是把泳池水中的污物经过沙层的过滤后, 使干净水重新回到泳池内, 过滤用的沙是石英沙。而过滤程序是: 首先是缸头控制器上把手柄推向(FILTER)正常过滤, 然后启动水泵, 泳池水便透过水泵引入沙缸进水口, 之后由进水中流到分水器, 再流入沙缸内, 水经过沙的过滤流进缸的底部, 再经过滤管进入过滤主管, 水在管道中向上流往出水口, 之后由管道系统注入泳池中。

经过一段时间后累积的污物, 会影响水的流量。这个时候便需要进行清洗沙缸。把缸头控制器上的手柄推向(BACKWASH)倒冲洗, 水流便由过滤主管进入, 经缸底的过滤管排出, 水流从底部向上升, 把沙层内的污物排出。之后把控制器推向(RINSE)清洗管内之污物从沙缸排出。大约半分钟或1分钟后, 把手柄推向(FILTER)正常过滤。

注意: 转换阀门位置时要先关掉水泵电源。

INSTALLATION 安装说明

Only simple tools (screwdriver and wrenches), plus pipe sealant for plastic adapters, are required to install and service the filter.

- 1) The filter should be placed on a level concrete slab, very firm ground, or equivalent. Position the filter so that the piping connections, control valve are convenient and accessible for operation and service.
- 2) Loading the sand media. Filter sand media is loaded through the top opening of the filter.
 - a) Loosen flange clamp and remove filter control valve (if previously installed).
 - b) Cap internal pipe with plastic cap to prevent sand from entering it.
 - c) We recommend filling tank approximately 1/2 way with water to provide a cushion effect when the filter sand is poured in. This helps protect the under-drain laterals from excessive shock.
 - d) Carefully pour in correct amount and grade of filter sand. (Be sure center pipe remains centered in opening.) Sand surface should be leveled and should come to about the middle of the filter tank. Remove plastic cap from internal pipe.
- 3) Assemble filter control valve to filter tank.
 - a) Insert filter control valve (with O'ring in place) into the tank neck, taking care that the center pipe slips into the hole in the bottom of the valve.
 - b) Place two plastic clamps around valve flange and tank flange and tighten just enough so that the valve may be rotated on tank for final positioning.
 - c) Carefully screw pressure gauge (with O'ring in place) into tapped hole in valve body. Do not over-tighten.
 - d) Connect pump to control valve opening marked PUMP. After connections are made, tighten valve flange clamps with screwdriver, tapping around clamp with screwdriver handle to help seat valve flange clamp.

- 4) Make return to pool pipe connection to control valve opening marked RETURN and complete other necessary plumbing connections, suction lines to pump, waste, etc.
- 5) Make electrical connections to pump per pump instructions.
- 6) To prevent water leakage, be sure all pipe connections are tight.

安装或修理沙缸只需简单工具（螺丝刀、活动扳手等），喉管接驳到胶接头上。

- 1) 沙缸要放置在平坦和坚硬的地上，要有足够的位置给与管道系统和缸头的安装，预留通道以便操作和修理。
- 2) 沙缸是装沙的器皿，沙是由沙缸顶部倒入。
 - a) 拧开颈夹上的螺丝，然后打开缸头（之前已装过）。
 - b) 过滤主管有密封盖，防止污物流到管道中。
 - c) 我们建议：在沙缸内注入适当份量沙后，再加入半缸水作为缓冲效用。这样便可保护到缸底的过滤管过度的冲击而做成损坏。
 - d) 小心加入正确数量的沙（保持过滤主管正中位置）沙的表面要铺平，大约加到沙缸的一半时，过滤主管上的盖便可打开。
- 3) 装配沙缸头
 - a) 插入沙缸头（附有胶垫圈）进入缸颈位，要小心过滤主管接合缸头底部的孔。
 - b) 放置2个颈环夹围绕着沙缸头法兰和沙缸顶法兰，同时把它适当地扭紧，以便使沙缸头在缸上操作。
 - c) 小心把压力表（附有密封圈）装上缸头上，但不要扭太紧。
 - d) 水泵初步接到缸头，之后管道安妥，扭紧缸头夹。
- 4) 接驳管道由出水口到泳池过滤回水口，同时各管道安装要求平行或垂直，另外要由进水口连接到水泵的出水口等等。
- 5) 接驳好电源后给水泵运作。
- 6) 为了防止漏水，使用前检查所有管道是否接合妥当。

MAIN DIMENSION 沙缸尺寸图

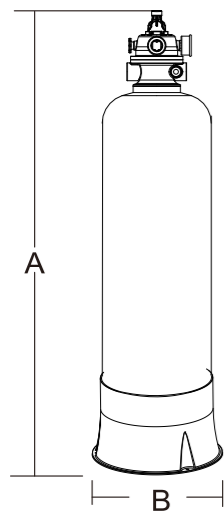

DIMENSION TABLE 尺寸表

Model 型号	High 高 mm A	Diameter 直径 mm B	Valve Port Size 多向阀管径 Inch	Sand 沙重 kg
HD13300	1300	343	1"	75
HD13350	1300	390	1"	98
HD13400	1300	450	1"	130
HD15300	1500	343	1"	86
HD15350	1500	390	1"	118
HD15400	1500	450	1"	154

INSTALL/START-UP OF FILTER 调试说明

- 1) Be sure correct amount of filter media sand is in tank and that all connections have been made and are secure.
- 2) Depress control valve handle and rotate to BACKWASH position. (To prevent damage to control valve seal, always depress handle before turning.)
- 3) Prime and start pump according to pump instructions (be sure all suction and return lines are open), allowing the filter tank to fill with water. Once water is flowing out of the waste line, run the pump for at least 1 minute. The initial back-washing of the filter is recommended to remove any impurities or fine sand particles in the sand media.
- 4) Turn pump off and set valve to RINSE position. Start pump and operate until water in sight glass is clear, about 1/2 to 1 minute. Turn pump off and set valve to FILTER position and restart pump. The filter is now operating in the normal filter mode, filtering dirt particles from the pool water.
- 5) Adjust pool suction and return valves to achieve desired flow. Check system and filter for water leaks and tighten connections, bolts, nuts, as required.
- 6) Note the initial pressure gauge reading when the filter is clean. (It will vary from pool to pool depending upon the pump and general piping system.) As the filter removes dirt and impurities from the pool water, the accumulation in the filter will cause the pressure to rise and flow to diminish. When the pressure gauge reading is 1.5 bar, higher than the initial "clean" pressure you noted, it is time to backwash the filter (see BACKWASH under filter and control valve functions).

NOTE: During initial clean-up of the pool water it may be necessary to backwash frequently due to the unusually heavy initial dirt load in the water.

- 1) 确定沙缸内的沙数量正确，同时所有管道系统连接妥当。
 - 2) 将阀门控制手柄压下再转向倒冲洗位置，为了防止阀门控制密封装置不受损坏，用阀门控制前一定要先压下手柄才转动。
 - 3) 按照水泵程序启动（确定所有进水和出水管道是开启）给水进入沙缸。作为首次启动系统，水泵最少也运行一分钟，另外建议最初先使用反冲洗功能，因为可以除去系统内的污垢或过滤沙中较细的粒子。
 - 4) 停水泵，同时沙缸头转向清洗及排出污物的位置。之后开水泵，直至清水镜的水清澈，大约半至一分钟，便停泵。这时沙缸便进入正常过滤模式，把泳池水的污物过滤。
 - 5) 调节过滤系统适合的水流。然后再检查系统，沙缸和接合位置是否漏水，螺栓或螺母等是否妥当。
 - 6) 当沙缸清洁时便摘录下压力表的读数。（读数的变化将会受泳池水泵和水管系统影响）。如沙缸过滤池水把污物留下，而累积污物会造成压力上升和水流减慢。当压力表读数是1.5巴，相对比当初（清洁）记录要高，这时要使用反冲洗沙缸。（参考反冲洗功能简介）。
- 注意：在过滤系统启动初期，将要多次使用反冲洗功能，因为初期的泳池水一定有污垢，流入沙缸便会积聚较多污垢和微粒。

REPLACEMENT PARTS OF FILTER 沙缸组件位置图

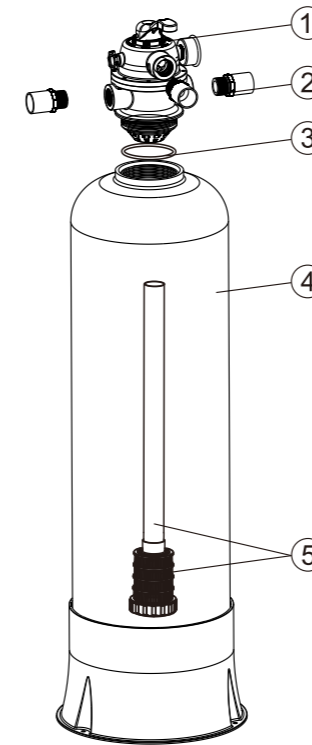

项目	部件编号	中文	產品資料/說明	数量
key No.	Part No.	Chinese	Product Description	Qty
1	88281206	高压缸头	1.0" Top Mount High-Pressure Valve	1
2	01150001	1寸外牙咀	1" Union	3
3	02020024	膠圈	O-Ring for Filter Neck	1
4	89012701	HD13300沙缸身连底座	HD13300 Filter Tank With Base	1
	89012702	HD15300沙缸身连底座	HD15300 Filter Tank With Base	1
	89012703	HD13350沙缸身连底座	HD13350 Filter Tank With Base	1
	89012704	HD15350沙缸身连底座	HD15350 Filter Tank With Base	1
	89012705	HD13400沙缸身连底座	HD13400 Filter Tank With Base	1
	89012706	HD15400沙缸身连底座	HD15400 Filter Tank With Base	1
5	89012707	HD13300\HD13350\HD13400中心管带过滤芯	HD13300\HD13350\HD13400 Lateral Assembly with Center Pipe	1
	89012708	HD15300\HD15350\HD15400中心管带过滤芯	HD15300\HD15350\HD15400 Lateral Assembly with Center Pipe	1

REPLACEMENT PARTS OF MULTIPOINT VALVE 多向阀组件位置图

项目	部件编号	中文	產品資料/說明	数量
key No.	Part No.	Chinese	Product Description	Qty
1	01013042	高压缸头手柄	Handle for 1.5" High-Pressure Valve	1
2	03018010	手柄固定销	Pin for Handle	1
3	01181001	大介子	Washer for Handle	1
4	01270002	高压缸头上身	1.5" High-Pressure Valve Cover	1
5	03011033	M6×25圆头机丝	M6×25 Screw With Nut	8
6	03013001	M6螺母	M6 Nut	8
7	02020015	胶圈φ16(外)×φ3	O-Ring	1
8	01013044	高压缸头排气螺丝	1.5" High-Pressure Valve Air Release Valve	1
9	01111048	压力表牙套	Connector for Pressure Gauge/Stopper	1
10	02020014	胶圈φ16(外径)×φ2.5	O-Ring Drain Plug	1
11	01111017	扭制	Drain Plug with O-Ring	1
12	02020015	压力表胶圈	O-Ring for Pressure Gauge	1
13	06011031	底出油压力表100psi	S/S Pressure Gauge With O-ring (100Psi)	1
14	01181002	小介子	Washer for Spring	1
15	02010001	胶圈φ27.5(外)×φ19.5X3.5	O-Ring for Rotor	2
16	03014014	弹簧	Spring	1
17	01021005	高压缸头分水器	1.5" High-Pressure Valve Rotor	1
18	02011012	分水器止水圈	Spider Gasket	1
19	02011144	胶圈	O-Ring for 1.5" High-Pressure Valve Body	1
20	01020008	高压缸头下身	1.5" High-Pressure Valve Body Assembly	1
21	02011008	清水镜胶垫	Sight Glass	1
22	01041004	清水镜	O-Ring for Sight Glass	1
23	01013043	高压缸头出水篮	1.5" High-Pressure Valve Diffuser	1
24	02011016	胶圈	O-Ring for Diffuser	1
25	02020024	高压缸头颈环夹圈	O-Ring	1
26	01150001	1寸外牙咀英制1寸	1" Union (A)	3
	01150050	1寸外牙咀公制1寸	1" Union (E)	3

