

## WORKING PROCESS 工作过程

It has to be done with the pump stopped and valves in position. 每次调节前应关掉水泵，并使蝶阀处于正确位置。

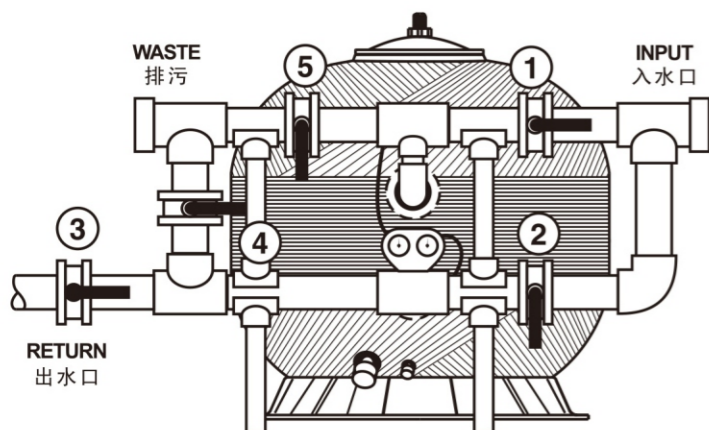

	①	②	③	④	⑤
<b>FILTER</b> 正常过滤	open 打开	close 关闭	open 打开	close 关闭	close 关闭
<b>BACKWASH</b> 倒冲洗	close 关闭	open 打开	close 关闭	close 关闭	open 打开
<b>RINSE</b> 底管清洗	open 打开	close 关闭	close 关闭	open 打开	close 关闭
<b>WASTE</b> 无过滤排水	open 打开	close 关闭	close 关闭	close 关闭	open 打开
<b>RECIRCULATE</b> 无过滤循环	close 关闭	open 打开	open 打开	close 关闭	close 关闭

## EMPTYING OF FILTER'S SAND 换沙

To change sand or filtration elements, proceed as follows:

- Remove top lid.
- Drain filter's water and sand through the lower drainage hole.
- If there is not enough room, sand can be removed through the manhole.
- To refill the filter with sand, follow the instructions given in starting, checking first of all that the drainage hole has been perfectly fitted and that it does not leak water.

换沙时，依照以下方法：

- 移掉顶盖；
- 从底部的排水孔和排沙孔排出沙缸内的水和沙；
- 如果位置不够沙也可以从顶部的孔拿出来；
- 当再装沙时，检查排水孔和排沙孔是否漏水和安装好，然后依照前面的说明装沙。

## OTHER RECOMMENDATIONS 其它建议

- If the equipment has been stopped during a long period of time, it is advisable to empty the water filter.
- If the filter is situated outside, it is advisable to paint it with a suitable product every two years.
- In standard filters, ozone water treatments must not be used and pressure and temperature specifications must not be exceeded. Contact our technical department if you have any doubt about the use of our filter.
- 如果设备长时间停止使用，建议把沙缸内的东西排走。
- 假如过滤沙缸安装在户外，建议每两年在其表面上漆一次。
- 标准设计的过滤沙缸，是不能用于被臭氧处理的水，而且压力和温度不能超出规定要求，如你有任何疑问，请联络我们的技术部门。

## GUARANTEE 优质保证

This filter has been manufactured using the best high technology materials and manufacturing process, going through strict quality tests on materials, finishes and performance.

All those bumps, rips and breakages caused by an inadequate use of the product or by ignoring our recommendations are not included in this guarantee.

These guarantees include only the replacement of defective parts. Further charges, as those works made by third parties, compensations, etc., will not be accepted by the manufacturer.

这个沙缸的制造，是用高品质的物料和制造程序，经过严格的品质测试完成。所有不按说明书要求使用，造成撞击、破裂等损坏的，不在保修范围。

## SAND FILTER 过滤沙缸

Models (型号): NL1200 / NL1400 / NL1600 / NL1800 / NL2000 / NL2300 / NL2500

## INTRODUCTION 介绍

This manual provides the necessary instructions to install, use and maintain bobbin wound filters. In order to obtain the benefits that are indicated in the characteristics, all the instructions that appear in this manual must be followed. This will offer a safe and long-lasting installation. The equipment's supplier will provide further information to the user whenever it is needed.

这份说明书提供了玻璃纤维沙缸的安装、使用和维护说明。为使沙缸正常工作，必须遵照说明去做，这样才能确保安全及使用寿命。当有需要时本产品供应商会向您提供更新的资料。

### 1) Description.

These filters have been designed to provide water filtration in pools and water parks, also for all water treatments that require the elimination of suspended matter using the proper reduction of filtration element.

Apart from the filter itself, filtration and depuration process include some points that must be taken into account as they can influence the correct filter operation. These would be chemical water treatment, pump equipment, pipe segments and general hydraulic design.

When public pools are concerned, the current rules in each country should be observed, as the installation must follow them.

The filtration quality depends on different parameters as depth of filtration bed, characteristics, quality and grade of filtration media, etc., as well as filtration rate.

### 2) Filter's Characteristics.

The tank is made of resin of polyester and glass fiber, totally anticorrosive. Inside, it contains collectors and diffusers made of unalterable plastic material (PVC and ABS), proof against salt-water. They are supplied for a working pressure of 2.5 kg/cm<sup>2</sup> to 4 kg/cm<sup>2</sup> and maximum temperature of 43°C. Other specifications can be supplied upon request. Filtration rates may be 20, 30, 40 and 50 m<sup>3</sup>/h/m<sup>2</sup>, depending on the application and the kind of filtration elements that have been selected. Rate 50 is not advisable in public pools.

### 1) 描述

本沙缸设计用于水池及水上乐园的水过滤循环，也可用于要求适当减少滤材，去除水中悬浮物的所有水处理，撇开沙缸不论，使用中其它一些因素会影响沙缸的正常操作，这些因素包括化学液体处理，水泵设备，水管和水压设计。

每个地方的公共泳池都有一定的规则，安装时必须依照地方的规则做，过滤的效果依赖于过滤床的深度，滤材的等级和品质以及过滤速度等等。

### 2) 过滤特性

缸体是采用聚酯树脂和玻璃纤维而成，完全防腐蚀，而内部的集水器和分水器是采用耐用的胶料(PVC和ABS)制成，能对抗盐水的考验。它能承受的压力是2.5kg/cm<sup>2</sup>至4.0kg/cm<sup>2</sup>，最高温度43°C。其它规格按要求提供。过滤速度可以是20, 30, 40, 50m<sup>3</sup>/h/m<sup>2</sup>，决定在于你所用的滤材、出入口管径、水泵扬程和流量，用于公共泳池建议过滤速度不能超过50 m<sup>3</sup>/h/m<sup>2</sup>。

## SPECIFICACIONES 结构图

Item 项目	Description 名称	Qty 数量
1	Nut,Lid 螺母	1
2	Lid's fixing bridge 铁板	1
3	Lid with bolt 顶盖、螺栓	1
4	Diffuser 分水斗	1
5	Flange 法兰	1
6	Instrument Panel 压力表表板	1
7	Lateral 过滤底管	1
8	Drain for sand 底排沙孔	1
9	Drain for water 底排水孔	1
10	Base 底座	1
11	Vent tube 排气管	1

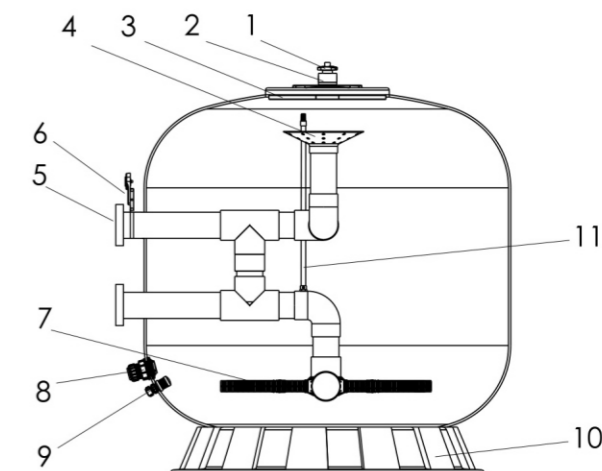



## INSTALLATION 安装

### 1) Filter installation

Filters are delivered properly packed and ready in order to facilitate unloading and transport using fork-lift truck, crane, etc. It is very important to make sure that the filters have not suffered bumps during transport.

To obtain a correct filter installation, the following stages must be observed:

- Install filters in their final location.
- Install correctly the butterfly valves in the filters.
- To connect with the flange of the filter, use PN1.6MPa or Class E 15bar PVC pipe.
- Install butterfly valves supports and regulate them correctly (height, etc.)
- Connect butterfly valves with the pipe of the pumps, return pipes and drain.
- Check the inner parts of each filter (collectors, top diffusers).
- Fill the filters with water.
- Empty half the water and add the filtration element (gravel, sand and/or anthracite), etc.

### 1) 沙缸安装

出货时沙缸已作适当包装，便于装卸和运输途中用叉车、吊车等搬运，重要的是要确保沙缸在运输途中不能遭受撞击。

依照以下的程序来正确地安装沙缸：

- 放置沙缸时，一定要决定最后的位置。
- 正确安装蝴蝶阀。
- 连接缸体法兰处的PVC管为PN1.6MPa或classE 15bar。
- 安装承托阀的设备和调整正确的高度。
- 连接蝴蝶阀及水泵，回水和排水管道。
- 检查每个沙缸的内部配件集水器、分水器、排气管）。
- 放水入沙缸内。
- 放走一半水，然后加入碎石、沙或无烟煤等。

#### 1.1) Filters location.

It is acceptable to place the filters under the water level.

However if vacuum occurs in the installation, suction cups must be installed in the lids to avoid that depression could collapse the filter's tanks.

Filters must be situated so that their bases are perfectly level and completely supported by the floor.

The location must be of appropriate size to allow maintenance periodic overhauls and other work. Additionally the room must provide a drain to allow, in case of accident, evacuation of water flowing from any tube, filter, pump, etc. this will avoid risk of damages in the electrical installations (pumps, electric panels, etc.)

#### 1.1) 沙缸位置

请设置沙缸在水位线下，沙缸必须放平，和由地面平均地承托，不能倾斜。

位置旁必须有足够空间，允许进行定期的保养、全面的检查和其它工作。另外在机房一定要有排水，当遇上意外时，把水管、沙缸、水泵内的水排走，这会避免漏水的危险（如水泵、电箱等）。

#### 1.2) Manometers.

The manometer panel had been installed in the filter. In pools filters, the usual pressures when the filter is clean are:

- Inlet pressure: 0.8-1 Kg/cm<sup>2</sup>.
- Outlet pressure: 0.4-0.6 Kg/cm<sup>2</sup>.

When the differential pressure between the two manometers is 1 Kg/cm<sup>2</sup> or higher, backwash must be carried out.

#### 1.2) 压力表

压力表表板已安装好，当滤材清洁时，在泳池通常压力是：

- 入口压力：0.8-1kg/cm<sup>2</sup>
- 出口压力：0.4-0.6kg/cm<sup>2</sup>

当两个压力表相差1kg/cm<sup>2</sup>或以上时，一定要进行倒冲洗。

## STARTING 启动

Before filling filters with sand or other filtration elements, it is advisable to check the internal collectors to make sure that they have not been damaged during transport or installation. Afterwards, fill the filters with water and make hydraulic test. Thus, you will make sure that there is no leak and that the equipment works properly. Then stop the pumps, open each filter's lid (the filter must not be emptied without opening the lid, as it could collapse) and empty half the water that each filter contains. Then, start filling the filter with sand or other filtration elements, taking into account that first of all you must put gravel up to the collector arms (10 cm approx.) This must be done very carefully in order to avoid any damage in the lower components of the filter. When the filter is being filled with sand, this must be carefully spread over the surface. Once the filter is full with the filtration elements clean the lid and the inner part of the manhole. This will prevent any debris and particles of sand affecting the seal of the joint.

当装沙或其它滤材入沙缸前，你要检查缸内部的集水器，肯定沙缸在运送时没有损坏，然后注入清水，做水力测试，确保设备无漏水及运作正常，然后停止水泵，打开顶盖，同时放走缸内一半的水，然后开始装沙和其它滤材入沙缸。这时一定要小心，避免造成任何底部沙缸零件的损坏，当沙缸装入沙后，沙面一定要平。要清洁顶盖和沙缸上孔，防止有沙和杂物影响顶盖密封。

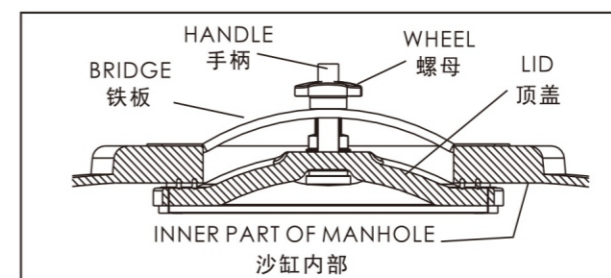

Introduce the lid in the manhole, leaving it leveled and centered. The lid must be supported by the handle, as this will avoid that it could fall into the tank and damage any of its parts. Put the bridge in the position shown and tighten manually the wheel. To achieve a proper seal, you do not have to tighten excessively the wheel, as this could damage the lid. The pressure itself will improve the seal.

When the filter is under pressure, it is normal that wheel and bridge remain separated. You must not tighten the wheel again when the filter is under pressure, because when the pumps stop, the lid could be damaged or blocked.

握住顶盖手柄，放入沙缸上的孔，保持水平居中，避免跌入沙缸，破坏内部的配件。放置铁板在图的位置，用手收紧螺母，但不需要过分收紧螺母，这可能会令顶盖受损，缸内压力自然会使顶盖密封。

当缸内有压力时，螺母和铁板会正常地分隔开，你不要再次收紧螺母，因为当水泵停止时，顶盖可能会损坏或阻塞。

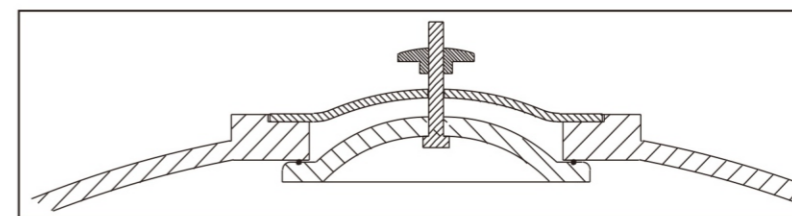

Once the filter has been completely filled with water, start the performance of installation, venting manually to eliminate all the air that could be inside the filter, as the presence of air the filter performance.

After this, the filter has been ready for working process.

当沙缸注满水，试运行，要排出缸内所有的空气，因为空气的存在会影响过滤功能。排完空气之后，沙缸就可以开始正常工作。



## WORKING PROCESS 工作过程

It has to be done with the pump stopped and valves in position. 每次调节前应关掉水泵，并使蝶阀处于正确位置。

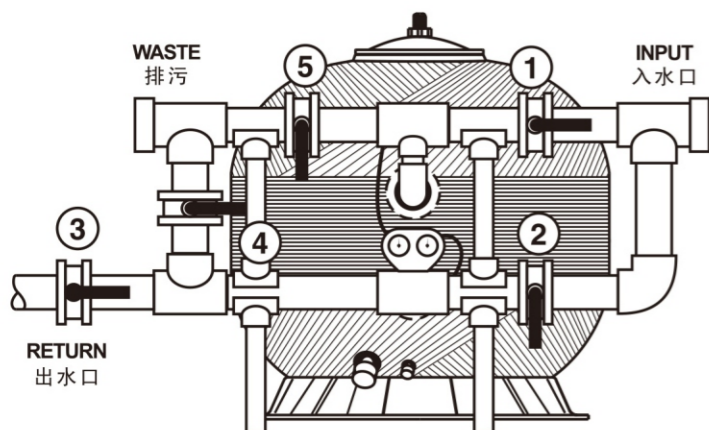

	①	②	③	④	⑤
<b>FILTER</b> 正常过滤	open 打开	close 关闭	open 打开	close 关闭	close 关闭
<b>BACKWASH</b> 倒冲洗	close 关闭	open 打开	close 关闭	close 关闭	open 打开
<b>RINSE</b> 底管清洗	open 打开	close 关闭	close 关闭	open 打开	close 关闭
<b>WASTE</b> 无过滤排水	open 打开	close 关闭	close 关闭	close 关闭	open 打开
<b>RECIRCULATE</b> 无过滤循环	close 关闭	open 打开	open 打开	close 关闭	close 关闭

## EMPTYING OF FILTER'S SAND 换沙

To change sand or filtration elements, proceed as follows:

- Remove top lid.
- Drain filter's water and sand through the lower drainage hole.
- If there is not enough room, sand can be removed through the manhole.
- To refill the filter with sand, follow the instructions given in starting, checking first of all that the drainage hole has been perfectly fitted and that it does not leak water.

换沙时，依照以下方法：

- 移掉顶盖；
- 从底部的排水孔和排沙孔排出沙缸内的水和沙；
- 如果位置不够沙也可以从顶部的孔拿出来；
- 当再装沙时，检查排水孔和排沙孔是否漏水和安装好，然后依照前面的说明装沙。

## OTHER RECOMMENDATIONS 其它建议

- If the equipment has been stopped during a long period of time, it is advisable to empty the water filter.
- If the filter is situated outside, it is advisable to paint it with a suitable product every two years.
- In standard filters, ozone water treatments must not be used and pressure and temperature specifications must not be exceeded. Contact our technical department if you have any doubt about the use of our filter.
- 如果设备长时间停止使用，建议把沙缸内的东西排走。
- 假如过滤沙缸安装在户外，建议每两年在其表面上漆一次。
- 标准设计的过滤沙缸，是不能用于被臭氧处理的水，而且压力和温度不能超出规定要求，如你有任何疑问，请联络我们的技术部门。

## GUARANTEE 优质保证

This filter has been manufactured using the best high technology materials and manufacturing process, going through strict quality tests on materials, finishes and performance.

All those bumps, rips and breakages caused by an inadequate use of the product or by ignoring our recommendations are not included in this guarantee.

These guarantees include only the replacement of defective parts. Further charges, as those works made by third parties, compensations, etc., will not be accepted by the manufacturer.

这个沙缸的制造，是用高品质的物料和制造程序，经过严格的品质测试完成。所有不按说明书要求使用，造成撞击、破裂等损坏的，不在保修范围。

## SAND FILTER 过滤沙缸

Models (型号): NL1200 / NL1400 / NL1600 / NL1800 / NL2000 / NL2300 / NL2500

## INTRODUCTION 介绍

This manual provides the necessary instructions to install, use and maintain bobbin wound filters. In order to obtain the benefits that are indicated in the characteristics, all the instructions that appear in this manual must be followed. This will offer a safe and long-lasting installation. The equipment's supplier will provide further information to the user whenever it is needed.

这份说明书提供了玻璃纤维沙缸的安装、使用和维护说明。为使沙缸正常工作，必须遵照说明去做，这样才能确保安全及使用寿命。当有需要时本产品供应商会向您提供更新的资料。

### 1) Description.

These filters have been designed to provide water filtration in pools and water parks, also for all water treatments that require the elimination of suspended matter using the proper reduction of filtration element.

Apart from the filter itself, filtration and depuration process include some points that must be taken into account as they can influence the correct filter operation. These would be chemical water treatment, pump equipment, pipe segments and general hydraulic design.

When public pools are concerned, the current rules in each country should be observed, as the installation must follow them.

The filtration quality depends on different parameters as depth of filtration bed, characteristics, quality and grade of filtration media, etc., as well as filtration rate.

### 2) Filter's Characteristics.

The tank is made of resin of polyester and glass fiber, totally anticorrosive. Inside, it contains collectors and diffusers made of unalterable plastic material (PVC and ABS), proof against salt-water. They are supplied for a working pressure of 2.5 kg/cm<sup>2</sup> to 4 kg/cm<sup>2</sup> and maximum temperature of 43°C. Other specifications can be supplied upon request. Filtration rates may be 20, 30, 40 and 50 m<sup>3</sup>/h/m<sup>2</sup>, depending on the application and the kind of filtration elements that have been selected. Rate 50 is not advisable in public pools.

### 1) 描述

本沙缸设计用于水池及水上乐园的水过滤循环，也可用于要求适当减少滤材，去除水中悬浮物的所有水处理，撇开沙缸不论，使用中其它一些因素会影响沙缸的正常操作，这些因素包括化学液体处理，水泵设备，水管和水压设计。

每个地方的公共泳池都有一定的规则，安装时必须依照地方的规则做，过滤的效果依赖于过滤床的深度，滤材的等级和品质以及过滤速度等等。

### 2) 过滤特性

缸体是采用聚酯树脂和玻璃纤维而成，完全防腐蚀，而内部的集水器和分水器是采用耐用的胶料(PVC和ABS)制成，能对抗盐水的考验。它能承受的压力是2.5kg/cm<sup>2</sup>至4.0kg/cm<sup>2</sup>，最高温度43°C。其它规格按要求提供。过滤速度可以是20, 30, 40, 50m<sup>3</sup>/h/m<sup>2</sup>，决定在于你所用的滤材、出入口管径、水泵扬程和流量，用于公共泳池建议过滤速度不能超过50 m<sup>3</sup>/h/m<sup>2</sup>。

## SPECIFICACIONES 结构图

Item 项目	Part No. 部件编号	Description 名称	Qty 数量
1	E012023	Lid 顶盖	1
2	4106191835	Manometer Set for NL1200 NL1200表板	1
2	4106191836	Manometer Set for NL1400/NL1600 NL1400/NL1600表板	1
2	4106196471	Manometer Set for NL1800/NL2000 NL1800/NL2000表板	1
2	4106196472	Manometer Set for NL2300/NL2500 NL2300/NL2500表板	1
3	E012061	Nozzles 蘑菇头	*

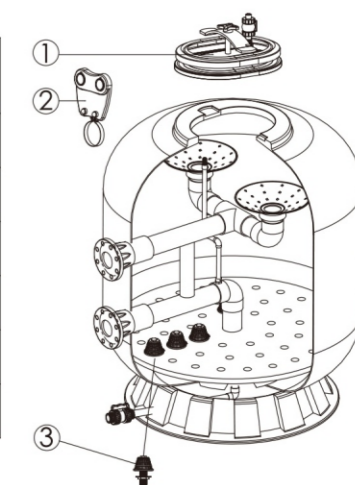



## INSTALLATION 安装

### 1) Filter installation

Filters are delivered properly packed and ready in order to facilitate unloading and transport using fork-lift truck, crane, etc. It is very important to make sure that the filters have not suffered bumps during transport.

To obtain a correct filter installation, the following stages must be observed:

- Install filters in their final location.
- Install correctly the butterfly valves in the filters.
- To connect with the flange of the filter, use PN1.6MPa or Class E 15bar PVC pipe.
- Install butterfly valves supports and regulate them correctly (height, etc.)
- Connect butterfly valves with the pipe of the pumps, return pipes and drain.
- Check the inner parts of each filter (collectors, top diffusers).
- Fill the filters with water.
- Empty half the water and add the filtration element (gravel, sand and/or anthracite), etc.

### 1) 沙缸安装

出货时沙缸已作适当包装，便于装卸和运输途中用叉车、吊车等搬运，重要的是要确保沙缸在运输途中不能遭受撞击。

依照以下的程序来正确地安装沙缸：

- 放置沙缸时，一定要决定最后的位置。
- 正确安装蝴蝶阀。
- 连接缸体法兰处的PVC管为PN1.6MPa或classE 15bar。
- 安装承托阀的设备和调整正确的高度。
- 连接蝴蝶阀及水泵，回水和排水管道。
- 检查每个沙缸的内部配件集水器、分水器、排气管）。
- 放水入沙缸内。
- 放走一半水，然后加入碎石、沙或无烟煤等。

#### 1.1) Filters location.

It is acceptable to place the filters under the water level.

However if vacuum occurs in the installation, suction cups must be installed in the lids to avoid that depression could collapse the filter's tanks.

Filters must be situated so that their bases are perfectly level and completely supported by the floor.

The location must be of appropriate size to allow maintenance periodic overhauls and other work. Additionally the room must provide a drain to allow, in case of accident, evacuation of water flowing from any tube, filter, pump, etc. this will avoid risk of damages in the electrical installations (pumps, electric panels, etc.)

#### 1.1) 沙缸位置

请设置沙缸在水位线下，沙缸必须放平，和由地面平均地承托，不能倾斜。

位置旁必须有足够空间，允许进行定期的保养、全面的检查和其它工作。另外在机房一定要有排水，当遇上意外时，把水管、沙缸、水泵内的水排走，这会避免漏电的危险（如水泵、电箱等）。

#### 1.2) Manometers.

The manometer panel had been installed in the filter. In pools filters, the usual pressures when the filter is clean are:

- Inlet pressure: 0.8-1 Kg/cm<sup>2</sup>.
- Outlet pressure: 0.4-0.6 Kg/cm<sup>2</sup>.

When the differential pressure between the two manometers is 1 Kg/cm<sup>2</sup> or higher, backwash must be carried out.

#### 1.2) 压力表

压力表表板已安装好，当滤材清洁时，在泳池通常压力是：

- 入口压力：0.8-1kg/cm<sup>2</sup>
- 出口压力：0.4-0.6kg/cm<sup>2</sup>

当两个压力表相差1kg/cm<sup>2</sup>或以上时，一定要进行倒冲洗。

## STARTING 启动

Before filling filters with sand or other filtration elements, it is advisable to check the internal collectors to make sure that they have not been damaged during transport or installation. Afterwards, fill the filters with water and make hydraulic test. Thus, you will make sure that there is no leak and that the equipment works properly. Then stop the pumps, open each filter's lid (the filter must not be emptied without opening the lid, as it could collapse) and empty half the water that each filter contains. Then, start filling the filter with sand or other filtration elements, taking into account that first of all you must put gravel up to the collector arms (10 cm approx.) This must be done very carefully in order to avoid any damage in the lower components of the filter. When the filter is being filled with sand, this must be carefully spread over the surface. Once the filter is full with the filtration elements clean the lid and the inner part of the manhole. This will prevent any debris and particles of sand affecting the seal of the joint.

当装沙或其它滤材入沙缸前，你要检查缸内部的集水器，肯定沙缸在运送时没有损坏，然后注入清水，做水力测试，确保设备无漏水及运作正常，然后停止水泵，打开顶盖，同时放走缸内一半的水，然后开始装沙和其它滤材入沙缸。这时一定要小心，避免造成任何底部沙缸零件的损坏，当沙缸装入沙后，沙面一定要平。要清洁顶盖和沙缸上孔，防止有沙和杂物影响顶盖密封。

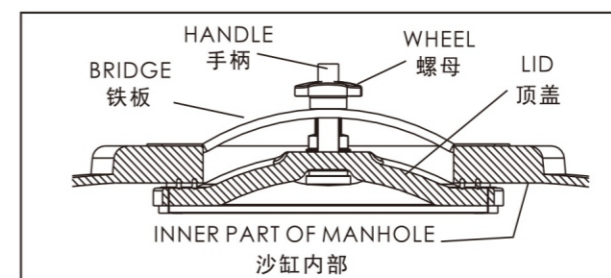

Introduce the lid in the manhole, leaving it leveled and centered. The lid must be supported by the handle, as this will avoid that it could fall into the tank and damage any of its parts. Put the bridge in the position shown and tighten manually the wheel. To achieve a proper seal, you do not have to tighten excessively the wheel, as this could damage the lid. The pressure itself will improve the seal.

When the filter is under pressure, it is normal that wheel and bridge remain separated. You must not tighten the wheel again when the filter is under pressure, because when the pumps stop, the lid could be damaged or blocked.

握住顶盖手柄，放入沙缸上的孔，保持水平居中，避免跌入沙缸，破坏内部的配件。放置铁板在图的位置，用手收紧螺母，但不需要过分收紧螺母，这可能会令顶盖受损，缸内压力自然会使顶盖密封。

当缸内有压力时，螺母和铁板会正常地分隔开，你不要再次收紧螺母，因为当水泵停止时，顶盖可能会损坏或阻塞。

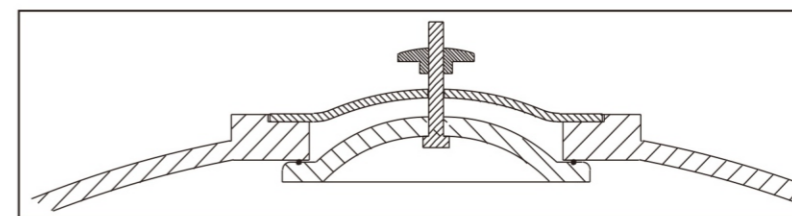

Once the filter has been completely filled with water, start the performance of installation, venting manually to eliminate all the air that could be inside the filter, as the presence of air the filter performance.

After this, the filter has been ready for working process.

当沙缸注满水，试运行，要排出缸内所有的空气，因为空气的存在会影响过滤功能。排完空气之后，沙缸就可以开始正常工作。